

Sandra A 40 (300x245)

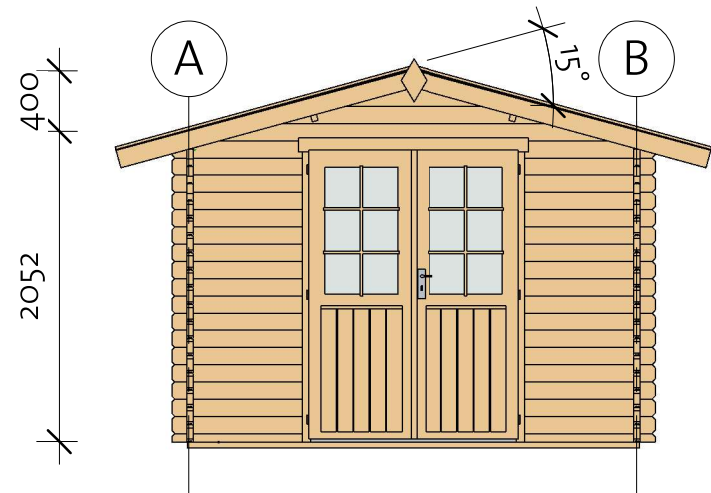

Sandra A 40 (300x245)

Foundation

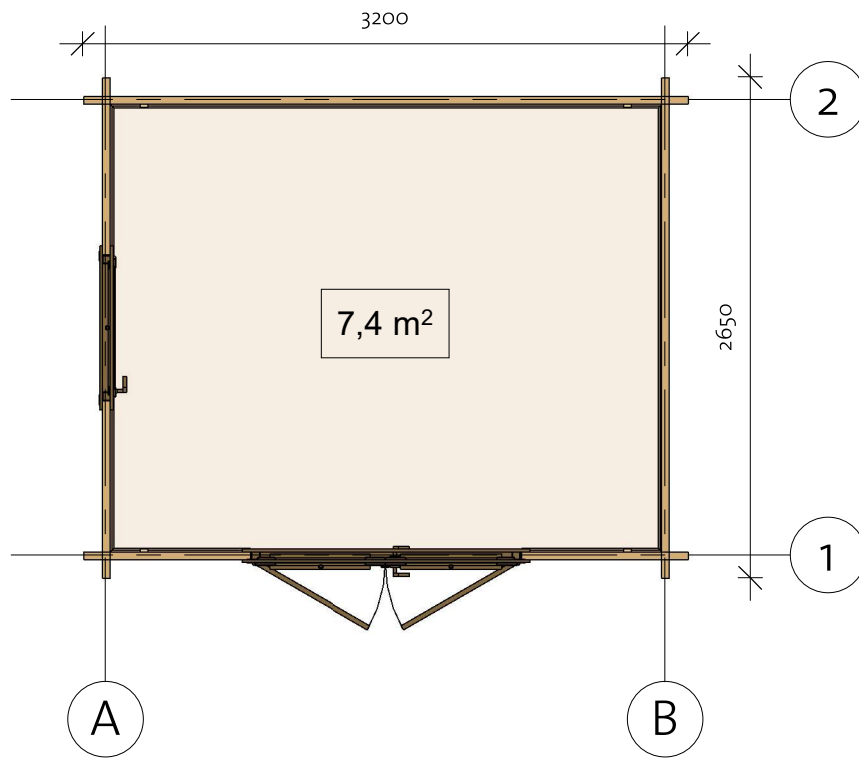
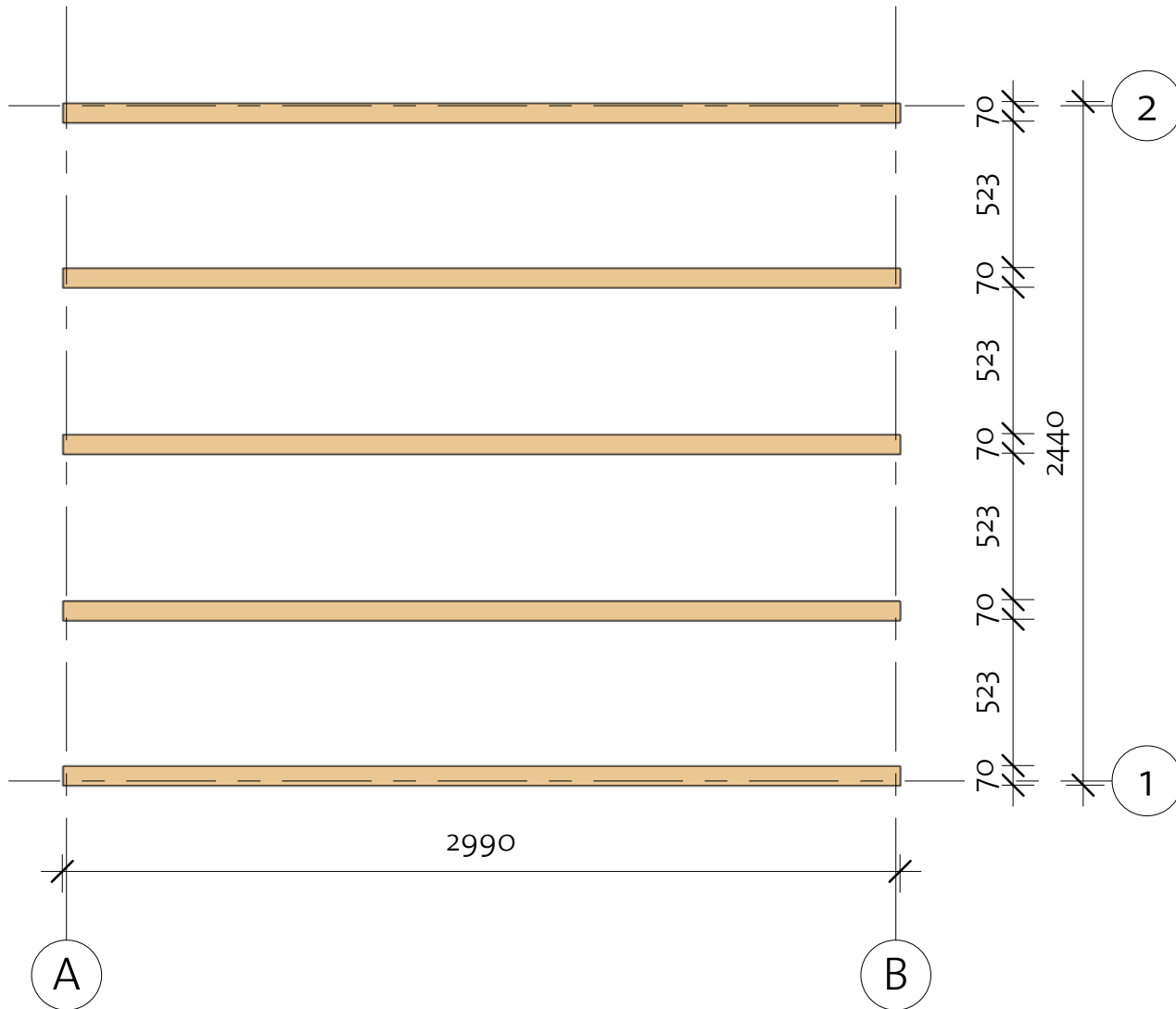

Impregnated foundation beams				
Mark	Type	Profile	Count	Length



IFB	IFB 70x40		5	2990
-----	--------------	---	---	------

Sandra A 40 (300x245)

Floor Plan

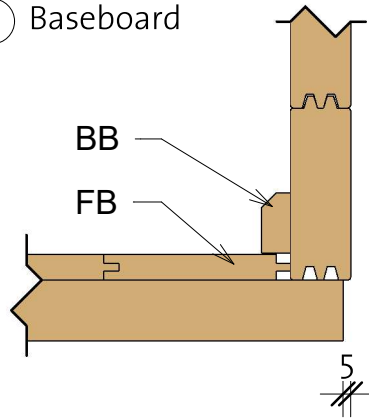
① Baseboard



Floor Schedule				
Mark	Type	Profile	Count	Length
FB	FB 17x114		27	2364
BB1	BB 20x40		2	3000
BB2	BB 20x40		2	2450

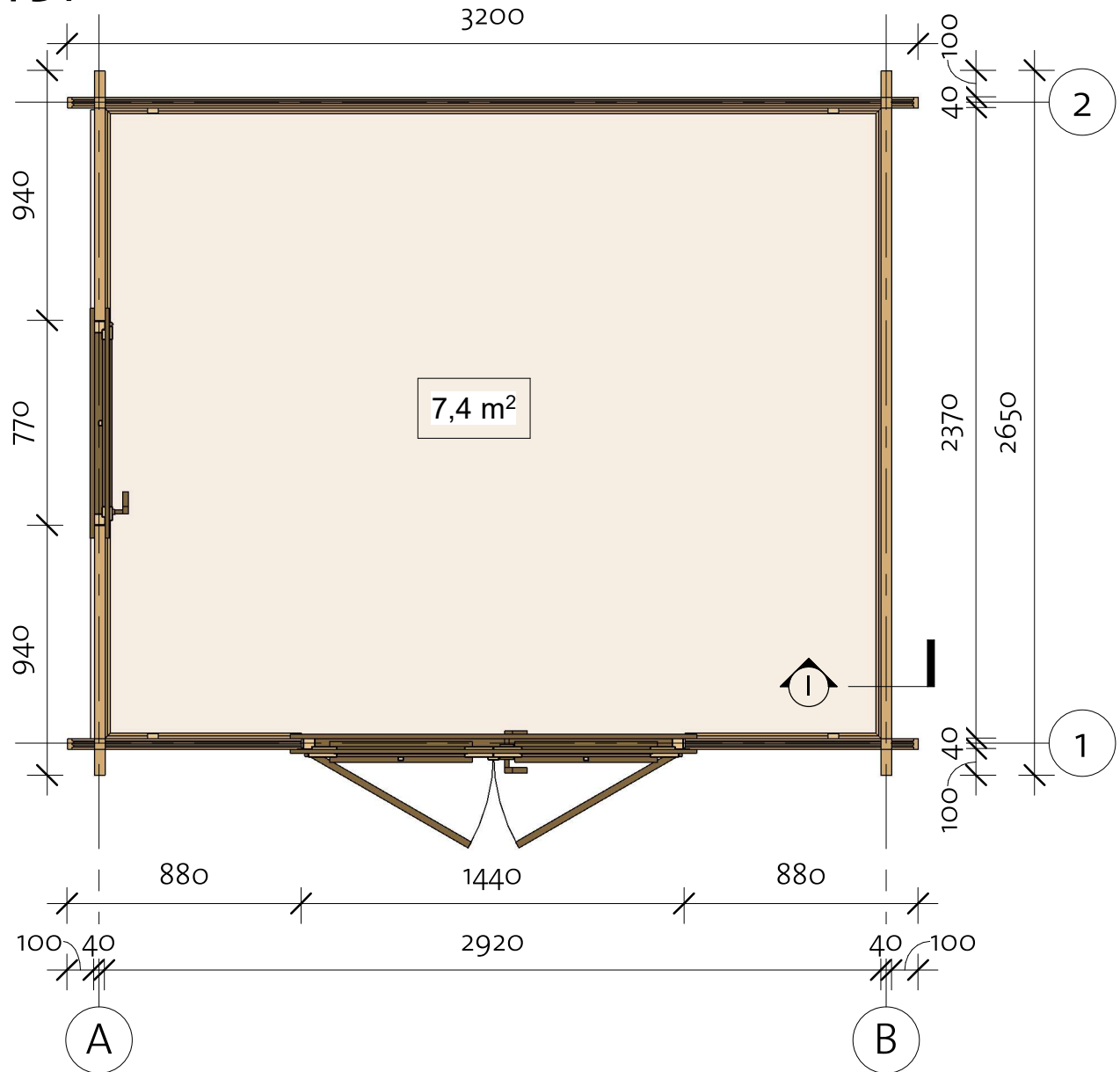

Sandra A 40 (300x245)

Wall 1

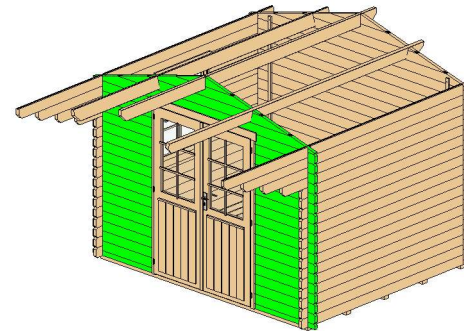

Wall 1			
Mark	Profile	Count	Cut Length

1BL-1	40x57	2	880
1LG-1 *	40x114	1	839
1LG-2	40x114	34	880
1LG-3 *	40x114	1	1671
1LG-4 *	40x114	1	2504
1LG-5 *	40x114	1	3198

* Gable - delivered premounted

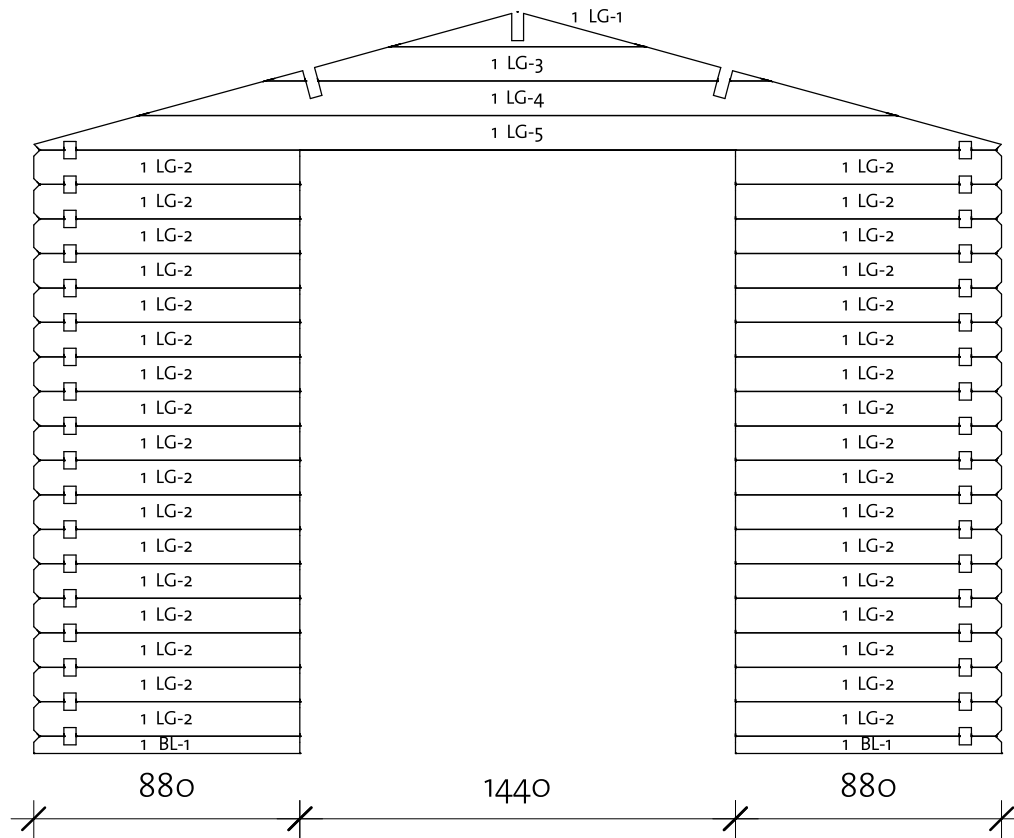

Log Profile Wall 1	
Profile	Profile

40x57	
40x114	

Sandra A 40 (300x245)

Wall 2

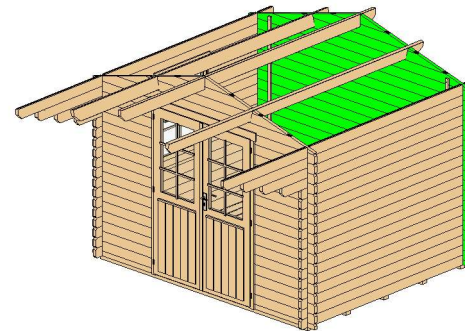

Wall 2			
Mark	Profile	Count	Cut Length

2BL-1	40x57	1	3200
2LG-1 *	40x114	1	839
2LG-2 *	40x114	1	1671
2LG-3 *	40x114	1	2504
2LG-4 *	40x114	1	3198
2LG-5	40x114	17	3200

* Gable - delivered premounted

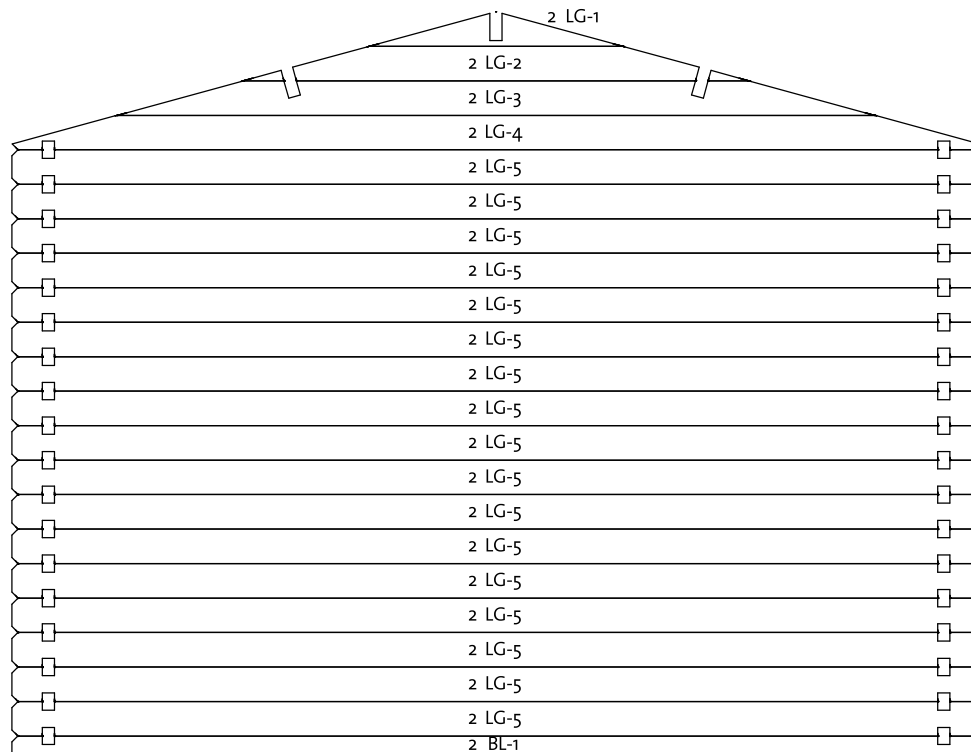

Log Profile Wall 2	
Profile	Profile

40x57	
40x114	

Sandra A 40 (300x245)

Wall A

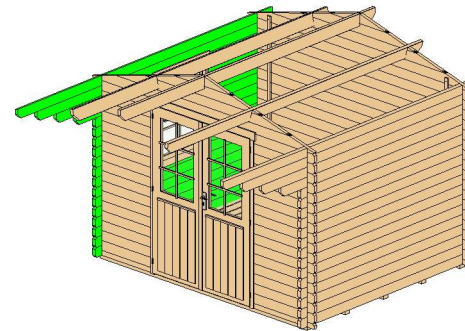

Wall A			
Mark	Profile	Count	Cut Length

ALG-1	40x114	16	940
ALG-2	40x114	1	1240
ALG-3	40x114	1	1540
ALG-4	40x114	7	2650
ALG-5	40x114	1	3550
ATL-1	40x114	1	3950

Log Profile Wall A	
Profile	Profile

40x114	
40x114	

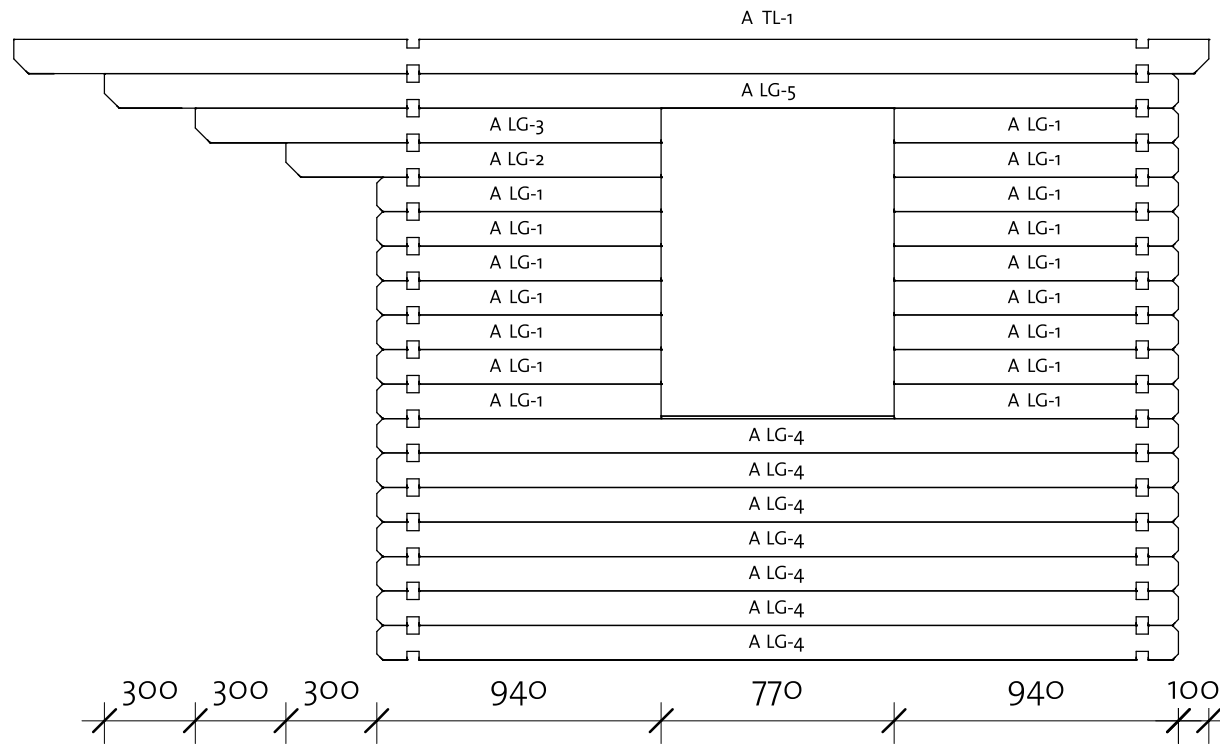

Sandra A 40 (300x245)

Wall B

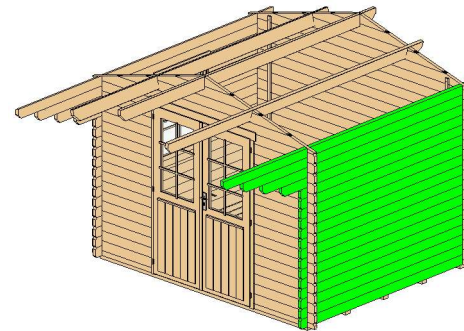

Wall B			
Mark	Profile	Count	Cut Length

BLG-1	40x114	14	2650
BLG-2	40x114	1	2950
BLG-3	40x114	1	3250
BLG-4	40x114	1	3550
BTL-1	40x114	1	3950

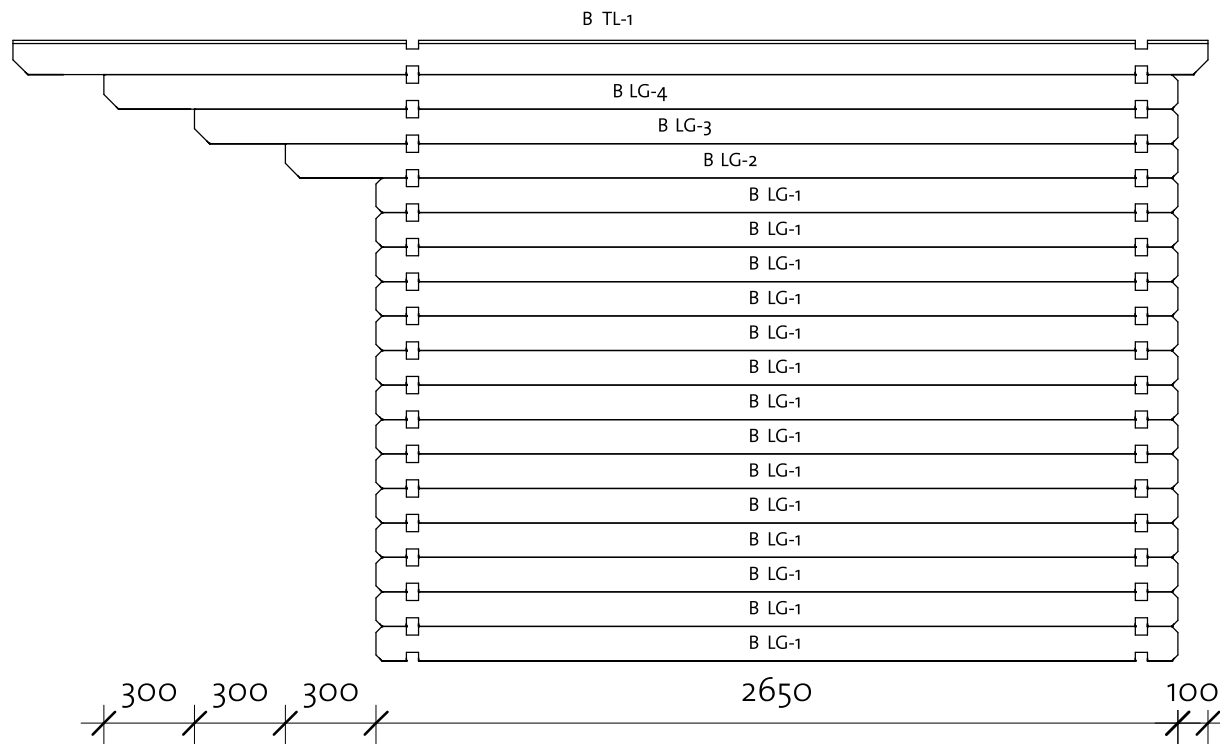





Log Profile Wall B	
Profile	Profile

40X114	
40X114	

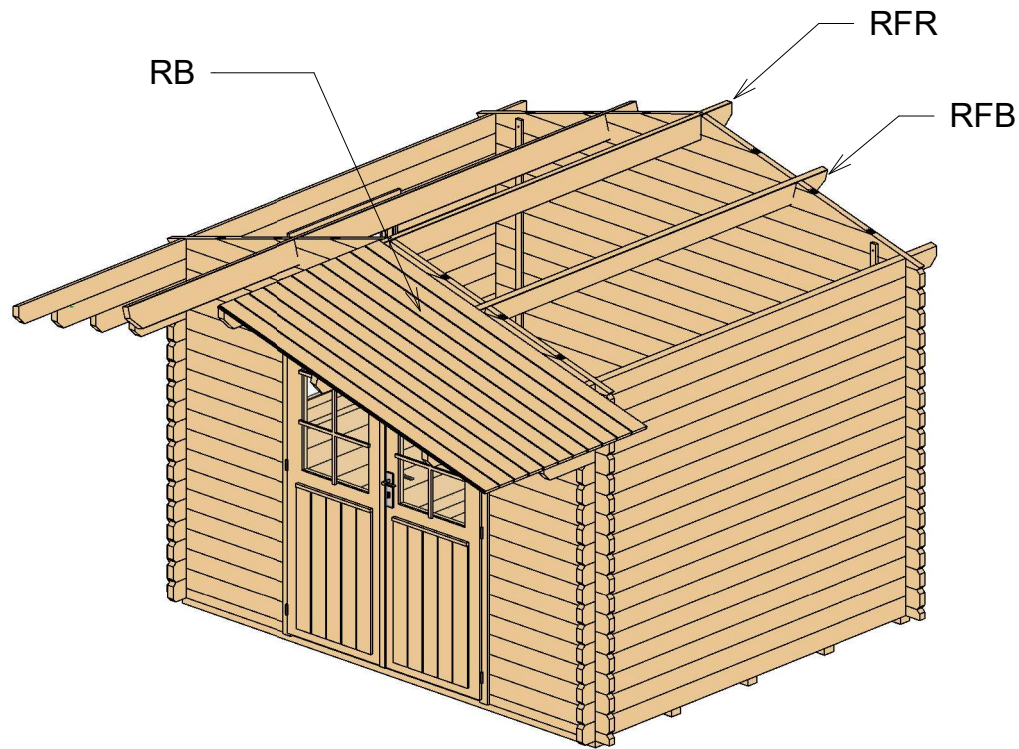
Sandra A 40 (300x245)

Roof 1



Roof				
Mark	Type	Profile	Count	Length
RFR	Ridge 40x143		1	3950
RFB	Beam 40x143		2	3950
RB	17x114		72	2002

Sandra A 40 (300x245)

Roof 2

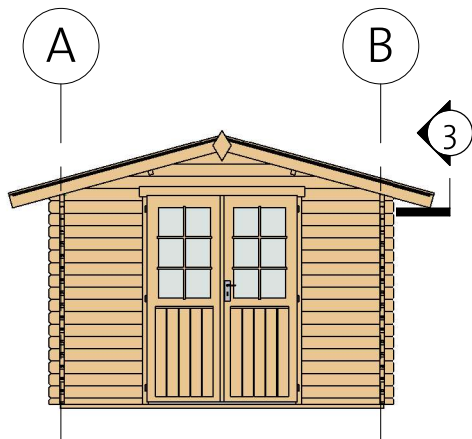
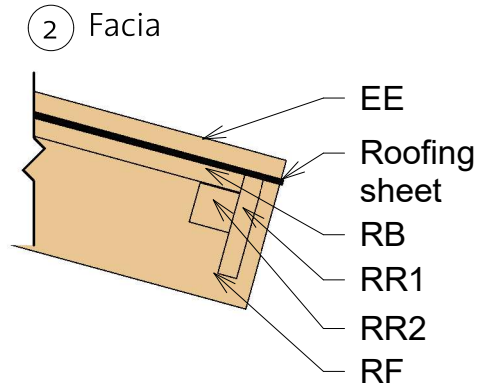
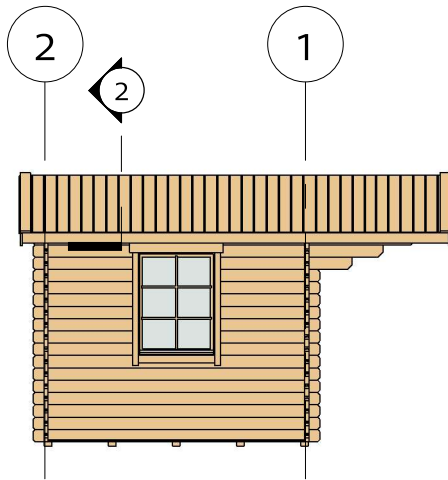

3 Roof Reinforcement

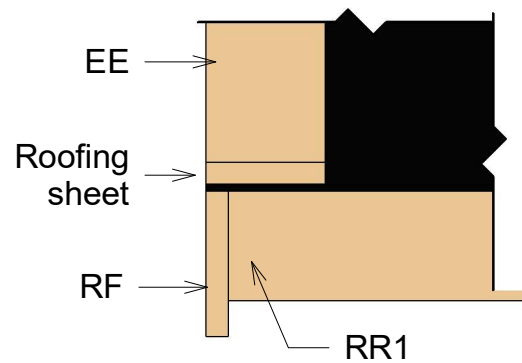

Fascia Schedule

Mark	Type	Profile	Count	Length
EE	Eave Edging 18x95		4	2040
RF	Roof Fascia 18x120		4	2040
RR1	Roof reinforcement 18x95		2	3950
RR2	Roof reinforcement 38x38		2	3950

Sandra A 40 (300x245)

Extras

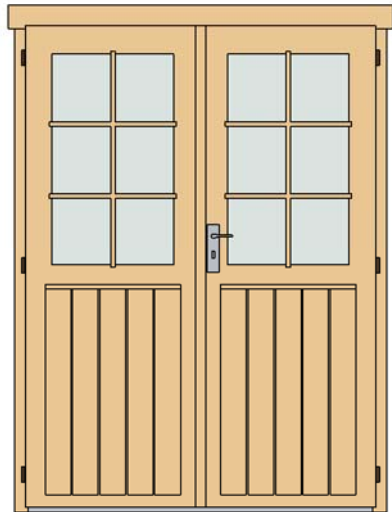

Door Schedule				
Mark	Type	Width	Height	Count
CDD1R	Classic double door 1 right	1425	1955	1
DCB6	Door Crossbar 6	--	--	2

Window Schedule				
Mark	Type	Width	Height	Count
CW1R	Classic window 1 right	765	990	1
WCB6	Windows Crossbar 6	--	--	1

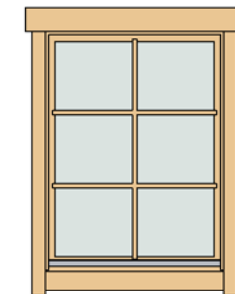

Fasteners & Extras		
Name	Type	Count

Hitblock	300-400 mm	
Screws	5,0 x 70	10
Bolts	M8 x 70	12
Screws	6,0 x 140	30
Nails	1,4 x 40	30
Screws	4,0 x 40	85
Screws	4,0 x 50	400



Type	Count	Length
------	-------	--------

Windboard 18x40	4	2200
-----------------	---	------

Family	Count
--------	-------

Romb	2
------	---



Sandra A 40 (300x245)

List of all items 1





Impregnated foundation beams

Mark	Type	Profile	Count	Length
IFB	IFB 70x40		5	2990

Floor Schedule



Mark	Type	Profile	Count	Length
FB	FB 17x114		27	2364

Fascia Schedule

Mark	Type	Profile	Count	Length
EE	Eave Edging 18x95		4	2040
RF	Roof Fascia 18x120		4	2040
RR1	Roof reinforcement 18x95		2	3950
RR2	Roof reinforcement 38x38		2	3950

BB1	BB 20x40		2	3000
BB2	BB 20x40		2	2450

Roof

Mark	Type	Profile	Count	Length
RFR	Ridge 40x143		1	3950
RFB	Beam 40x143		2	3950
RB	17x114		72	2002

Sandra A 40 (300x245)

List of all items 2

Wall 1			
Mark	Profile	Count	Cut Length

1BL-1	40x57	2	880
1LG-1 *	40x114	1	839
1LG-2	40x114	34	880
1LG-3 *	40x114	1	1671
1LG-4 *	40x114	1	2504
1LG-5 *	40x114	1	3198

* Gable - delivered premounted

Wall 2			
Mark	Profile	Count	Cut Length

2BL-1	40x57	1	3200
2LG-1 *	40x114	1	839
2LG-2 *	40x114	1	1671
2LG-3 *	40x114	1	2504
2LG-4 *	40x114	1	3198
2LG-5	40x114	17	3200



Wall A			
Mark	Profile	Count	Cut Length

ALG-1	40x114	16	940
ALG-2	40x114	1	1240
ALG-3	40x114	1	1540
ALG-4	40x114	7	2650
ALG-5	40x114	1	3550
ATL-1	40x114	1	3950

Wall B			
Mark	Profile	Count	Cut Length

BLG-1	40x114	14	2650
BLG-2	40x114	1	2950
BLG-3	40x114	1	3250
BLG-4	40x114	1	3550
BTL-1	40x114	1	3950

Log Profiles	
Profile	Profile

40x57	
40x114	

Log Profiles	
Profile	Profile

40x114	
--------	---